

# ROUND METAL CEILING LOUDSPEAKERS

- **RCS5FT/EN**
- **RCS5FT/ENC**

EN54-24



## INSTALLATION INSTRUCTIONS

EN54-24:2008

Certificate No: 0359-CPD-0120 TYPE A

1. LOUDSPEAKER ENCLOSURE
2. REFERENCE AXIS
3. REFERENCE PLANE
4. HORIZONTAL PLANE

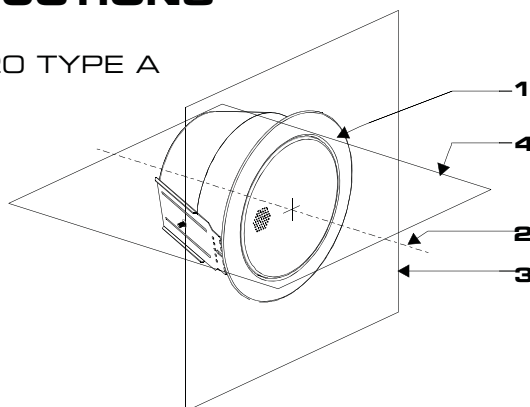

### Circuit Diagram

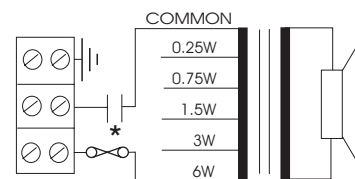

- **RCS5FT/EN**
- **RCS5FT/ENC**
- \* with capacitor

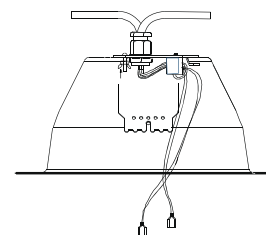
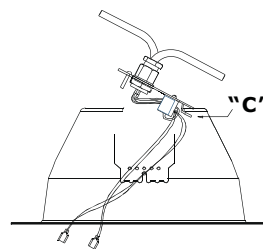
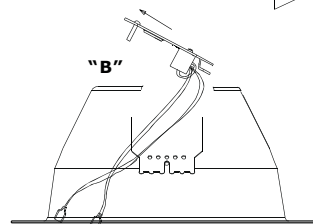
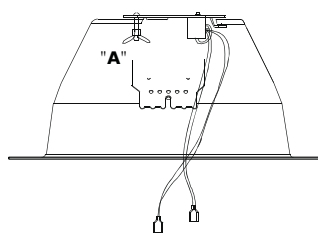

- **1.** Remove the wing nut "A" located on the inside of the fire dome.

- **2.** Lift the termination plate upwards & away to separate it from the fire dome "B".

- **3.** Gland the installation cable into the termination plate using suitably rated 20mm glands. 2 gland entries are provided for "loop in" "loop out" termination if required.

- 4.** Terminate the installation cable into the terminal block on the underside of the termination plate "C".

- 5.** Fix the termination plate back into the fire dome and secure using the wing nut previously removed. Do not over tighten to avoid damaging the thread.

### FITTING THE DOME INTO A CEILING

- 6.** Cut a 164mm diameter hole paying attention to ensure that the cut-out is accurately made. As if it is not, the speaker may not fit correctly into the ceiling preventing the speaker from sitting flush to the surface.

- 7.** Loosen the slider knob "D", push the knob & plate upwards to the top of the fire dome and re-tighten the knob to hold the slider in place. Repeat the same process with the other slider.

- 8.** Push the complete fire dome into the cut-out.

- 9.** Once in place loosen the slider knob "D", push the knob & plate downwards until the slider makes firm contact with the ceiling. Tighten the knob to secure it into place. Repeat the same process with the other slider.

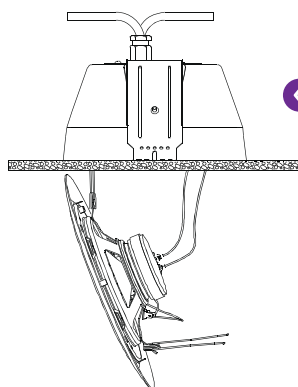
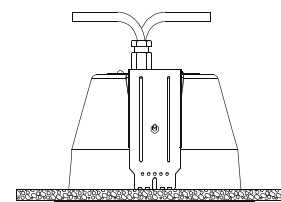
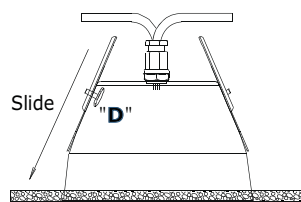

- **10.** The fire dome should be firmly secured into the ceiling.

- 11.** Take the speaker and compress one of the mounting springs & place both ends of the spring into one of the retaining brackets located on the inside wall of the fire dome. Release the spring slowly into the bracket. Once fully released the spring will hold one side of the speaker into the fire dome.

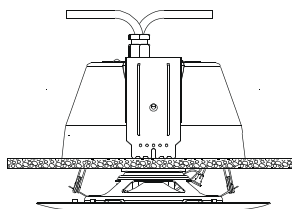

- **12.** With the speaker in this position connect the 3 wires hanging from the termination plate on to the speaker using the spade terminals provided.

- 13.** Fit the second spring mount on the speaker to the remaining bracket on the inside of the fire dome. Finally push the speaker into position.

- 14.** If fitted correctly the speaker should fit flush to the surface.



### Penton UK Ltd

Unit 2 Teville Industrials | Dominion Way | Worthing | West Sussex | BN14 8NW  
T: +44 (0)1903 215315 | F: +44(0)1903 215415 | E: sales@pentonuk.co.uk

[www.pentonuk.co.uk](http://www.pentonuk.co.uk)

OCTOBER 2011



RoHS

